

Dongguan Fvwin Electronics Co.,Ltd



Email:fvwin@fvwin.com | Skype:evelynhwang2013

<https://www.fvwin.com.cn> | <https://www.led-tact-switch.com>

Add:NO 168,Technology East Road, Shijie Town, 523290, Dongguan, Guangdong, CN

TS15 Series Illuminated Push Button Switch

Picture					
Model	TS15-9W56WTG-MENU-	TS15-10W57WTY-SOLO	TS15-12W58WTG-3	TS15-12W58WBG1	TS15-10W63WTR-X
Size(mm)	12(L)*12(W)*13.1(H)	15(L)*15(W)*12.7(H)	16(φ)*13.1(H)	16(φ)*13.1(H)	26(L)*15(W)*12.9(H)
Circuit	SPST	SPST	SPST	SPST	SPST
Function	OFF-(ON) Momentary	OFF-(ON) Momentary	OFF-(ON) Momentary	OFF-(ON) Momentary	OFF-(ON) Momentary
Rating	50mA 12VDC	50mA 12VDC	50mA 12VDC	50mA 12VDC	50mA 12VDC
Electrically Life	200,000 Cycles Min	200,000 Cycles Min	200,000 Cycles Min	200,000 Cycles Min	200,000 Cycles Min
Actuation Force	250±50gf	250±50gf	250±50gf	250±50gf	200±50gf
Total Travel	0.4±0.15mm	0.4±0.15mm	0.4±0.15mm	0.4±0.15mm	0.4±0.15mm



Audio/Video Illuminated Push Button Switch

Picture						
Model	PB24-0000R	PB24-0000RG	PB30B-0000R	PB34-0000R	PB30A-0000R	PB30A-0000G
Size(mm)	12(L)*12(W)*23(H)	12(L)*12(W)*23(H)	15(L)*15(W)*23(H)	17.4(L)*17.4(W)*22.65(H)	15(L)*15(W)*18.5(H)	15(L)*15(W)*18.5(H)
Circuit	SPST	SPST	SPST	SPST	SPST	SPST
Function	OFF-(ON) Momentary	OFF-(ON) Momentary	OFF-(ON) Momentary	OFF-(ON) Momentary	OFF-(ON) Momentary	Latching
Rating	100mA 12VDC	100mA 12VDC	100mA 12VDC	100mA 12VDC	5A 250VAC;0.4A 28VDC	5A 250VAC;0.4A 28VDC
Electrically Life	1,000,000 Cycles Min	1,000,000 Cycles Min	1,000,000 Cycles Min	100,000 Cycles Min	200,000 Cycles Min	200,000 Cycles Min
Actuation Force	250±100gf	250±100gf	250±100gf	250±100gf	200±100gf	200±100gf
Total Travel	4.5±0.2mm	4.5±0.2mm	4.5±0.2mm	4.5±0.2mm	2.2±0.5mm	2.2±0.5mm

Features:

1. Available in three different cap sizes of 12 mm, 15 mm, 16mm and 17.4 mm
2. Sculpted Clear Cap style or Laser etch on clear lens for design flexibility in audio/video applications
3. Available with super bright red, green, blue or bi-color or RGB LED
4. A best solution for all broadcast and Pro A/V panel need

TS7 Series Illuminated Tact Switch (RGB / Bi-color LED Options)

Picture						
Model	TS7-0000RGBA	TS7-0000RU	TS7-0000RG	TS7-0051WRG	TS7-0051BRU6	TS7-0051BRGB1
Outline Size(mm)	7(L)*7(W)*7(H)	7(L)*7(W)*7(H)	7(L)*7(W)*7(H)	φ10*8.2(H)	φ10*8.2(H)	φ10*8.2(H)
Cap Size(mm)	NON	NON	NON	φ10	φ10	φ10
Terminal Type	SMD	DIP	DIP	DIP	DIP	DIP
Rating	50mA 12VDC	50mA 12VDC	50mA 12VDC	50mA 12VDC	50mA 12VDC	50mA 12VDC
Lifespan	200,000 Cycles Min	200,000 Cycles Min	200,000 Cycles Min	200,000 Cycles Min	200,000 Cycles Min	200,000 Cycles Min
Actuation Force	160±50gf 250±50gf	160±50gf 250±50gf	160±50gf 250±50gf	160±50gf 250±50gf	160±50gf 250±50gf	160±50gf 250±50gf
Total Travel	0.25±0.1mm	0.25±0.1mm	0.25±0.1mm	0.25±0.1mm	0.25±0.1mm	0.25±0.1mm

Features:

RGB and Bi-color(Red-Blue&Red-Green&Red-White)LED Options

SMD and Thru-hole terminal







10MM Round shape cap are available

Tiny size and crispy sound feedback

TS8 Series Illuminated Tact Switch

Picture						
Model	TS8-0000WA	TS8-0000W	TS8-002AR	TS8-003BR1	TS8-0030AU1	TS8-007AW3
Outline Size(mm)	6(L)*6(W)*7(H)	6(L)*6(W)*7(H)	7.5(L)*7.5(W)*8.3(H)	φ7.5*8.3(H)	φ10*8.3(H)	φ10*8.3(H)
Cap Size(mm)	NON	NON	7.5*7.5	7.5(φ)*2.4(H)	φ10	φ10
Terminal Type	SMD	DIP	DIP	DIP	DIP	DIP
Lifespan	500,000 Cycles Min	500,000 Cycles Min	500,000 Cycles Min	500,000 Cycles Min	500,000 Cycles Min	500,000 Cycles Min
Actuation Force	160±50gf 250±50gf	160±50gf 250±50gf	160±50gf 250±50gf	160±50gf 250±50gf	160±50gf 250±50gf	160±50gf 250±50gf
Total Travel	0.25±0.1mm	0.25±0.1mm	0.25±0.1mm	0.25±0.1mm	0.25±0.1mm	0.25±0.1mm
Picture						
Model	TS8-1A1AR	TS8-1A2GR	TS8-3A3AR	TS8-3B3AU6	TS8-3B3TU	TS8-00TWR6
Outline Size(mm)	10(L)*10(W)*8.3(H)	10(L)*10(W)*8.3(H)	φ10 * 8.3(H)	φ10 * 8.3(H)	φ10 * 8.3(H)	7.5(L)*7.5(W)*16.3(H)
Cap Size(mm)	10*10	10*10	φ10	φ10	φ10	φ5.5*10.4(H)
Actuation Force	160±50gf 250±50gf	160±50gf 250±50gf	160±50gf 250±50gf	160±50gf 250±50gf	160±50gf 250±50gf	160±50gf 250±50gf

TS9 Series Illuminated Tact Switch







Picture						
Model	TS9-0000UA	TS9-0000R1	TS9-003TU	TS9-003BUX	TS9-001AR1	TS9-002AU
Size(mm)	6(L)*6(W)*9(H)	6(L)*6(W)*9(H)	7.5(φ)*10(H)	8(φ)*10(H)	7.5(L)*7.5(W)*10(H)	7.5(L)*7.5(W)*10(H)
Cap Size(mm)	NON	NON	φ7.5*2.4(H)	φ8*2.4(H)	7.5(L)*7.5(W)*2.4(H)	7.5(L)*7.5(W)*2.4(H)
Life	500,000 Cycles Min	500,000 Cycles Min	500,000 Cycles Min	500,000 Cycles Min	500,000 Cycles Min	500,000 Cycles Min
Actuation Force	250±50gf	250±50gf	250±50gf	250±50gf	250±50gf	250±50gf
Total Travel	0.25±0.1mm	0.25±0.1mm	0.25±0.1mm	0.25±0.1mm	0.25±0.1mm	0.25±0.1mm

Picture						
Model	TS9-005BW1	TS9-007BWX	TS9-007AWX	TS9-009WR1	TS9-005W19TX	TS9-0052WU
Size(mm)	10(L)*10(W)*10(H)	10(φ)*10(H)	10(φ)*10(H)	12.8(φ)*10(H)	12(L)*12(W)*11.5(H)	7.5(L)*7.5(W)*12(H)
Cap Size(mm)	7.5(L)*7.5(W)*2.4(H)	φ10*2.4(H)	φ10*2.4(H)	φ12.8*2.4(H)	12(L)*12(W)*5.0(H)	7.5(L)*7.5(W)*4.3(H)

Picture						
Model	TS9-3B3BU6	TS9-1B1WW	TS9-5B7GG	TS9-5B7BUW	TS9-5B7AU1	TS9-2A00U
Size(mm)	10(φ)*10(H)	10(L)*10(W)*10(H)	12.8(φ)*10(H)	12.8(φ)*10(H)	12.8(φ)*10(H)	11.1(L)*11.6(W)*9.8(H)
Cap Size(mm)	7.5(φ)*2.4(H)	10(L)*10(W)*2.4(H)	10(φ)*2.4(H)	10(φ)*2.4(H)	10(φ)*2.4(H)	NON

Picture						
Model	TS9-0012TU	TS9-00TWU	TS9-00TBU6	TS9-00TBU1	PB58-0000U	
Size(mm)	7(φ)*17.1(H)	7.5(L)*7.5(W)*17.8(H)	7.5(L)*7.5(W)*17.8(H)	7.5(L)*7.5(W)*17.8(H)	5.8(L)*5.8(W)*10.2(H)	
Cap Size(mm)	7 (φ)*7(L)*7(W)*9.4(H)	5.5(φ) *7.5(L)*7.5(W)*10.1(H)	5.5(φ) *7.5(L)*7.5(W)*10.1(H)	5.5(φ) *7.5(L)*7.5(W)*10.1(H)	/	
Total Travel	0.25±0.1mm	0.25±0.1mm	0.25±0.1mm	0.25±0.1mm	1.9±0.2mm	

TS10 Series Illuminated Tact Switch

Picture						
Model	TS10-0000G	TS10-0011UU	TS10-0061WU	TS10-00FWU	TS10-0013BR1	TS10-00FW17TWR
Size(mm)	6(L)*6(W)*9(H)	10(φ)*12.8(H)	9.0(L)*9.0(W)*13.35(H)	9.0(L)*9.0(W)*15.4(H)	φ13*15(H)	11(L)*11(W)*16.9(H)
Cap Size(mm)	NON	10(φ)*3.5(H)	9.0(L)*9.0(W)*5.9(H)	9.0(L)*9.0(W)*6.2(H)	φ13*7.5(H)	11(L)*11(W)*8.7(H)
Actuation Force	250±50gf	250±50gf	250±50gf	250±50gf	250±50gf	250±50gf
Total Travel	0.25±0.1mm	0.25±0.1mm	0.25±0.1mm	0.25±0.1mm	0.25±0.1mm	0.25±0.1mm

Features:

Red/Blue/Green/Yellow/White Colors and Bi-color LED Options

Surface Mount And Thru-hole mounting

Many caps are available

Accept to customize the icon on the top cap

TS16 Series Illuminated Tact Switch

Picture						
Model	TS16-0000RA	TS16-0000R	TS16-0000U-1	TS16-0000R-2	TS16-0000R-3	TS16-0000U-4
Size(mm)	7(L)*7(W)*6.8(H)	7(L)*7(W)*6.8(H)	7(L)*7(W)*6.8(H)	7(L)*7(W)*7(H)	7(L)*7(W)*7(H)	7(L)*7(W)*7(H)
Cap Size(mm)	NON	NON	NON	NON	NON	NON
Actuation Force	250±50gf	250±50gf	250±50gf	250±50gf	250±50gf	250±50gf
Total Travel	0.25±0.1mm	0.25±0.1mm	0.25±0.1mm	0.25±0.1mm	0.25±0.1mm	0.25±0.1mm

Picture						
Model	TS16-0023AR1	TS16-00EAR6	TS16-00EBG6	TS16-00EAR	TS16-0065RR	TS16-0055WR
Size(mm)	7.5(φ)*8(H)	7.5(φ)*12.1(H)	7.5(φ)*12.1(H)	7.5(φ)*12.1(H)	7.5(φ)*14.4(H)	8.0(φ)*15.5(H)
Cap Size(mm)	7.5(φ)*2.4(H)	7.5(φ)*6.3(H)	7.5(φ)*6.3(H)	7.5(φ)*6.3(H)	7.5(φ)*8.85(H)	8.0(φ)*10(H)







Red/Blue/Green/Yellow/White Colors and Bi-color LED Options





Surface Mount And Thru-hole mounting

Many caps are available

Accept to customize the symbol on the cap

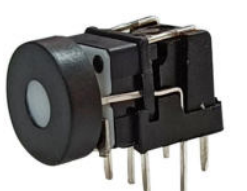
TS17 Series Right Angle Illuminated Tact Switch

Picture						
Model	TS17-0000W	TS17-0023BR1	TS17-0053AR1X	TS17-0024WU1	TS17-0021AU1	TS17-0027BG1
Cap Size(mm)	NON	7.5(φ)*2.4(H)	8.0(φ)*2.4(H)	7.5(L)*7.5(W)*2.4(H)	10(φ)*2.4(H)	10(L)*10(W)*2.4(H)
Terminal Type	Right Angle	Right Angle	Right Angle	Right Angle	Right Angle	Right Angle
Rating	50mA 12VDC	50mA 12VDC	50mA 12VDC	50mA 12VDC	50mA 12VDC	50mA 12VDC
Life	200,000 Cycles Min	200,000 Cycles Min	200,000 Cycles Min	200,000 Cycles Min	200,000 Cycles Min	200,000 Cycles Min
Actuation Force	160±50gf/250±50gf	160±50gf/250±50gf	160±50gf/250±50gf	160±50gf/250±50gf	160±50gf/250±50gf	160±50gf/250±50gf
Total Travel	0.25±0.1mm	0.25±0.1mm	0.25±0.1mm	0.25±0.1mm	0.25±0.1mm	0.25±0.1mm

Picture						
Model	TS17-8B00W	TS17-8B53BWX	TS17-8BEAR1	TS17-00EWU	TS17-00EBW1	TS17-0066WR
Cap Size(mm)	7.5(φ)*6.3(H)	8.0(φ)*2.4(H)	4.5(φ)*6.3(H)	4.5(φ)*6.3(H)	4.5(φ)*6.3(H)	7.5(φ)*8.85(H)
Terminal Type	Right Angle	Right Angle	Right Angle	Right Angle	Right Angle	Right Angle

TS20 Series Right Angle Illuminated Tact Switch

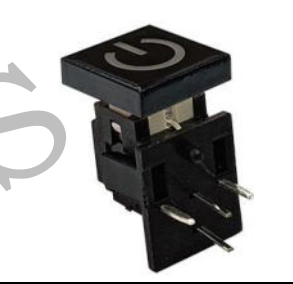
Picture						
Model	TS20-0000R	TS20-003BAR1	TS20-003BU1	TS20-0025WR	TS20-002AU	TS20-005BG1
Outline Size(mm)	6.0(L)*6.0(W)*12.0(H)	φ7.5*13.9(H)	φ7.5*13.9(H)	φ8.0*13.9(H)	7.5(L)*7.5(W)*13.9(H)	10(L)*10(W)*13.9(H)
Cap Size(mm)	NON	φ7.5*2.4(H)	φ7.5*2.4(H)	φ8.0*2.4(H)	7.5(L)*7.5(W)*2.4(H)	10(L)*10(W)*2.4(H)
Life	200,000 Cycles Min	200,000 Cycles Min	200,000 Cycles Min	200,000 Cycles Min	200,000 Cycles Min	200,000 Cycles Min
Actuation Force	250±50gf	250±50gf	250±50gf	250±50gf	250±50gf	250±50gf
Total Travel	0.25±0.1mm	0.25±0.1mm	0.25±0.1mm	0.25±0.1mm	0.25±0.1mm	0.25±0.1mm

Picture			
Model	TS20-007AR6	TS20-00TWR	TS20-00TAR6
Outline Size(mm)	φ12.8*13.9(H)	7.5(L)*7.5(W)*19.5(H)	7.5(L)*7.5(W)*19.5(H)
Cap Size(mm)	φ12.8*2.4(H)	7.5(L)*7.5(W)*2.4(H)	7.5(L)*7.5(W)*2.4(H)
Actuation Force	250±50gf	250±50gf	250±50gf

TS85 Series Latching Illuminated Push Button Switch

Picture						
Model	TS85-0000R	TS85-0000W	TS85-0028WR	TS85-0060AR6	TS85-0029AR1	TS85-0022AG1
Size(mm)	7.5(L)*8.5(W)*10(H)	7.5(L)*8.5(W)*10(H)	10(L)*10(W)*12.0(H)	7.5(φ)*13(H)	10(φ)*19.8(H)	10(φ)*20(H)
Cap Size(mm)	NON	NON	10(L)*10(W)*3.5(H)	7.5(φ)*3.3(H)	10(L)*10(W)*13.4 (H)	10(L)*10(W)*13.6 (H)
Rating	0.1A 30VDC	0.1A 30VDC	0.1A 30VDC	0.1A 30VDC	0.1A 30VDC	0.1A 30VDC
Actuation Force	250±100gf(Locking)	/	250±100gf(Locking)	250±100gf(Locking)	250±100gf(Locking)	250±100gf(Locking)
	150±100gf(Momentary)	150±100gf(Momentary)	150±100gf(Momentary)	150±100gf(Momentary)	150±100gf(Momentary)	150±100gf(Momentary)
Total Travel	1.6±0.4mm	1.6±0.4mm	1.6±0.4mm	1.6±0.4mm	1.6±0.4mm	1.6±0.4mm
Lock Travel	1.4±0.4mm	1.4±0.4mm	1.4±0.4mm	1.4±0.4mm	1.4±0.4mm	1.4±0.4mm

Features:





Red/Blue/Green/Yellow/White Colors and Bi-color LED Options

Latching function

Many caps are available

Accept to customize the symbol on the cap



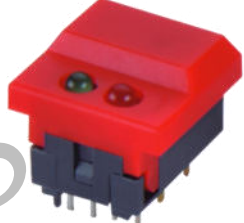

PB86 Series Illuminated Push Button Switch

Picture						
Model	PB86-A0ANN	PB86-A1PNR	PB86-A2GRG	PB86-B0WNN	PB86-B1BNR	PB86-B2RRG
Size(mm)	12.3(L)*17(W)*11.5(H)	12.3(L)*17(W)*11.5(H)	12.3(L)*17(W)*11.5(H)	17.4(L)*17(W)*11.5(H)	17.4(L)*17(W)*11.5(H)	17.4(L)*17(W)*11.5(H)
Function	Momentary	Momentary	Momentary	Momentary	Momentary	Momentary
Rating	12mA 24VDC	12mA 24VDC	12mA 24VDC	12mA 24VDC	12mA 24VDC	12mA 24VDC
Actuation Force	170±50gf	170±50gf	170±50gf	170±50gf	170±50gf	170±50gf
Total Travel	2.0±0.4mm	2.0±0.4mm	2.0±0.4mm	2.0±0.4mm	2.0±0.4mm	2.0±0.4mm

PB86 Features:

- 1.Red/Blue/Green/Yellow/White Colors and Bi-color LED Options,
- 2.Through Hole Mounting
- 3.Many caps are available
- 4.Accept to customize the symbol or text on the cap







TS3&4 Series Key Button Switch

Picture					
Model	TS3-AYN	TS3-BUN	TS4-2R	TS4-1A	TS4-3B
Size(mm)	12.4*12.4*8.7(H)	14.7*14.7*8.7(H)	φ11.5*10.5(H)	φ11.5*10.5(H)	φ 11.5*13.1(H)
Button Size(mm)	10.2*10.2	10.2*10.2	φ 8mm	8*8	φ 8mm
Circuit	SPST	SPST	Push (NO)	Push (NO)	Push (NO)
Function	OFF-(ON)Momentary	OFF-(ON)Momentary	OFF-(ON)Momentary	OFF-(ON)Momentary	OFF-(ON)Momentary
Rating	0.5A 30VDC;0.25A 50VDC	0.5A 30VDC;0.25A 50VDC	30mA 30VDC	30mA 30VDC	30mA 30VDC
Actuation Force	400±100gf/250±100gf	400±100gf/250±100gf	200±50gf	200±50gf	200±50gf
Total Travel	1.0mm±0.25mm	0.7mm±0.25mm	0.7mm±0.2mm	0.7mm±0.2mm	0.7mm±0.2mm

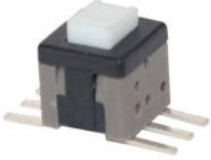
Features:

1. Multiple button color options and wear-resisting material
2. Different size selections
3. Gold plated contact, more reliable and good conductivity

Self-locking Push Button Switch







Picture						
Model	PB58-5881A	PB58-5810	PB58-5810R	PB70-7016	PB80-8013	PB85-8513
Size(mm)	5.8(L)*5.8(W)*8.1(H)	5.8(L)*5.8(W)*10.1(H)	5.8(L)*5.8(W)*10(H)	7(L)*7(W)*16(H)	8(L)*8(W)*13.5(H)	8.5(L)*8.5(W)*13.9(H)
Rating	0.1mA 30VDC	0.1mA 30VDC	0.1mA 30VDC	0.1mA 30VDC	0.1mA 30VDC	0.1mA 30VDC
Actuation Force	250±100gf	250±100gf	250±100gf	250±100gf	250±100gf	250±100gf
Total Travel	2.5±0.2mm	2.5±0.2mm	2.5±0.2mm	2.5±0.2mm	2.5±0.2mm	2.5±0.2mm
Function	latching/Momentary	latching/Momentary	latching/Momentary	latching/Momentary	latching/Momentary	latching/Momentary



Momentary Push Button Switch

Picture						
Model	PB04-BR	PB02-PMR	PB08-PPR-L	PB08-PPR		
Cut-out Size(mm)	12.8*11	φ16	φ12	φ12		
Rating	3A 125V DC AC/1.0A 250V AC	6A 125V AC/3A 250V AC	200mA 24V DC	200mA 250V AC		
Actuation Force	250±100gf	250±50gf	500±50gf	500±180gf		
Funtion	Latching	Momentary	Latching	Momentary		

Picture							
Model	PB01-PPG	PB10-BBR	PB05-AR	PB15-1511U	PB07-RB0R0		
Cut-out Size(mm)	φ12.7	φ12.5	φ7.5	15.6(L)*15.6(W)*11.1 (H)	15.1(L)*15.1(W)*15.4 (H)		
Actuation Force	150±100gf	350±100gf	250±50gf	60±10gf	200±50gf		
Funtion	Momentary	Momentary	Momentary	Momentary	Latching		

Mini Tactile Switch

Picture						
Model	TS45-45X	TS45-45XA	TS45-45R	TS52-52A	TS62-62R	SH-06D-01-2.5H
Size(mm)	4.5*4.5	4.5*4.5	4.5*4.5	5.2*5.2	6.2*6.2	6*6*6
Height(mm)	3.5/3.8/4.3/5/5.5/6/7/8	3.5/3.8/4.3/5/5.5/6/7/8	3.5/3.8/4.3/5/5.5/6/7/8	1.5/1.7/2.0/2.5/3.0/3.5	4.2/4.5/5/5.5/6/6.5/7/7.5-15	7.3MM
Actuation Force	100-350gf	100-350gf	100-350gf	100-350gf	100-350gf	100-350gf
Life Span	100,000 cycles min	100,000 cycles min	100,000 cycles min	100,000 cycles min	100,000 cycles min	100,000 cycles min

Picture						
Model	TS60-60105-S	TS60-6080	TS12-1273	TS62-6235	TS62-6252	TS62-6231A
Size(mm)	6*6*10.5	6*6*8	12*12*7.3	6.2*6.2*3.5	6.2*6.2*5.2	6.2*6.2*3.1
Height(mm)	10.5MM	8MM	7.3MM	3.1/3.5/4.3/5.0/5.2	3.1/3.5/4.3/5.0/5.2	3.1/3.5/4.3/5.0/5.2
Actuation Force	250gf	250gf	250gf	160/250gf	160/250gf	160/250gf
Life Span	100,000 cycles min	100,000 cycles min	100,000 cycles min	100,000 cycles min	100,000 cycles min	100,000 cycles min

DC Power Jack Connector

Picture						
Model	DC-003A-1.3	DC-005-2.0-PU-R	DC-012A-2.5-PU	DC-015-2.0-PU	DC-015F-2.0-PU	DC-016-2.0-PU
Rating	DC 30V 0.5A	DC 30V 0.5A	DC 30V 0.5A	DC 30V 0.5A	DC 30V 0.5A	DC 20V 2.5A
Centre Pin Dia	φ 1.3mm	φ 2.0mm	φ 2.0/2.5mm	φ 2.0/2.5mm	φ 2.0/2.5mm	φ 2.0/2.5mm
Insertion and withdraw Force	3-20N	3-20N	3-20N	3-20N	3-20N	3-20N
Life	5,000 cycles	3,000 cycles	3,000 cycles	5,000 cycles	5,000 cycles	5,000 cycles







Picture						
Model	DC-022A-2.0	DC-022D-2.0	DC-025BM-2.0	DC-044A-2.0-PU	DC-089-2.0	DC-511-2.0
Rating	DC 30V 0.5A	DC 30V 0.5A	DC 30V 0.5A	DC 30V 0.5A	DC 30V 0.5A	DC 12V 7A
Centre Pin	φ 2.0mm	φ 2.0/2.5mm	φ 2.0/2.5 mm	φ 2.0mm	φ 2.0mm	φ 2.0/2.5mm
Insertion and withdraw Force	3-20N	3-20N	3-20N	3-20N	3-20N	3-40N
Life	5000次	5,000 cycles	5,000 cycles	5,000 cycles	5,000 cycles	5,000 cycles

Picture						
Model	DC-515-2.0-PU	DC-522-2.0-	DC-528-2.0	DC-01240M-2.5		
Rating	DC 30V 0.5A	DC 30V 0.5A	DC 30V 0.5A	DC 30V 0.5A		
Centre Pin	φ 2.0mm	φ 2.0mm	φ 2.0mm	φ 2.0/2.5mm		
Insertion and withdraw Force	3-20N	3-20N	3-20N	3-20N		
Life	5,000 cycles	5,000 cycles	5,000 cycles	5,000 cycles		

AC Power Socket

Picture						
Model	S03-F11S	S03-11	S03-121	S03-12S4	S03F-114	
Rating	6.3A 250VAC(UL CUL) 6.3A 250VAC(VDE) 10A 250VAC(CCC)	15A 250V AC(UL CUL) 10A 250VAC(CCC)	15A 250V AC(UL CUL) 10A 250VAC(CCC)	15A 250V AC(UL CUL) 10A 250VAC(CCC)	6.3A 250VAC(UL CUL) 6.3A 250VAC(VDE) 10A 250VAC(CCC)	

Toggle Switch

Picture						
Model	TG8701-BRE	R8015P-R11-2-Q-H	T8013-UHBQ-H	TG8019	TG-0-123-A02-N005-RS	T8013-SNCQ-S20-H
Circuit	SPDT	DPDT	SPDT	SPDT	SPDT	SPDT
Function	ON-OFF	ON-ON	ON-OFF	ON-OFF	(ON)-OFF-(ON)	ON-ON

Metal Push Button Switch

Picture						
Cut-out Size(mm)	12	12	12	16	19	22
Function	Momentary/Latching	Momentary/Latching	Momentary/Latching	Momentary/Latching	Momentary/Latching	Momentary/Latching
Rated	5A 125VAC;3A 250VAC	5A 125VAC;3A 250VAC	5A 125VAC;3A 250VAC	5A 125VAC;3A 250VAC	5A 125VAC;3A 250VAC	5A 125VAC;3A 250VAC
LED color	R/U/G/W/Y	R/U/G/W/Y	R/U/G/W/Y	R/U/G/W/Y	R/U/G/W/Y	R/U/G/W/Y
Actuation Force	200±50gf	200±50gf	200±50gf	200±50gf	200±50gf	200±50gf
Life	50,000 Cycles Min	50,000 Cycles Min	50,000 Cycles Min	50,000 Cycles Min	50,000 Cycles Min	50,000 Cycles Min

Plastic Injection Mould

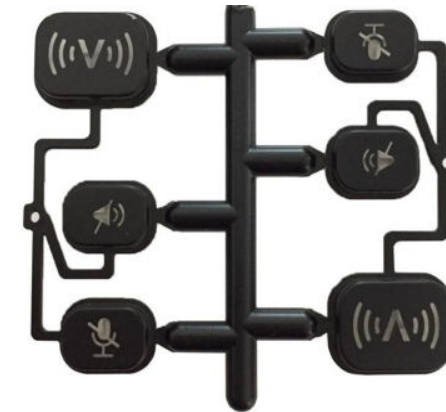

Features:

- Round and square cap options
- Welcome customized the symbol
- Provide Laser engraved service