

► Features

- Illuminated LED integrated
- Through-in and surface mount mount
- 500,000 long-life cycles
- Various single and bi-color LED optional
- Custom legends is available



► Applications

Panel control that requires tactile switch with illumination integrated.

Typical for applications in pro audio&video, industrial, medical, security device, communication

► Specification

MPN	TS8 series
Power Rating	12 VDC at 50mA
Insulation Resistance	100MΩ
Dielectrical Strength	250VAC for 1-minute
Operating Force	160gf/250gf
Travel	0.25+/-0.1mm
Function	Momentary

► Dimension

TS8-0000WA

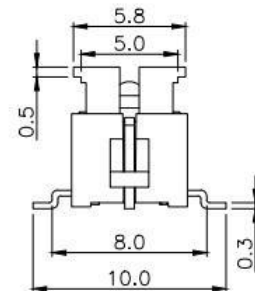
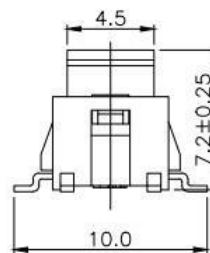
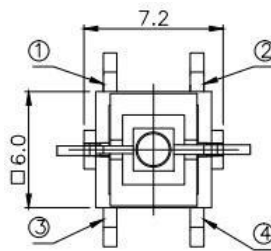

TS8-0000W

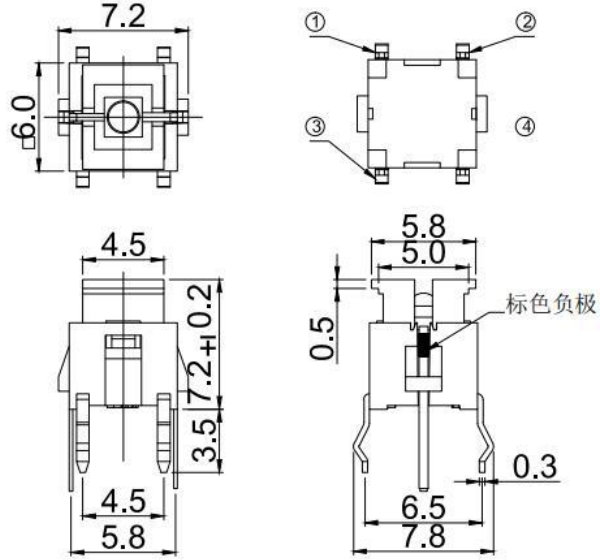

TS8-003BW1

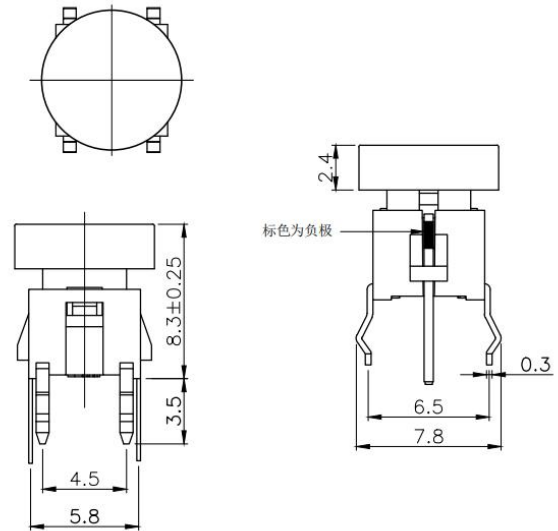

TS8-001AW1

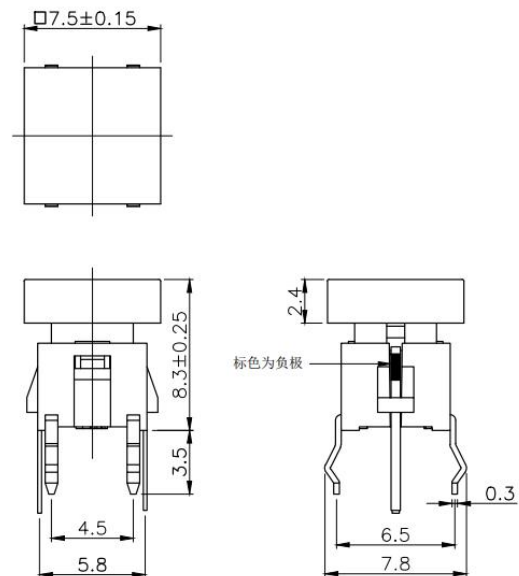

TS8-007WR

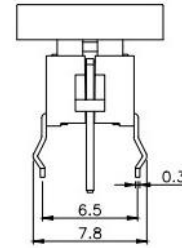
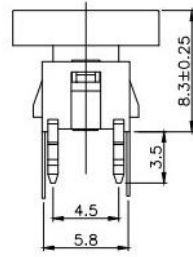
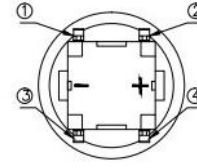
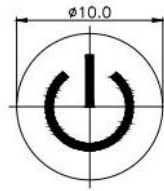

TS8-005BR1

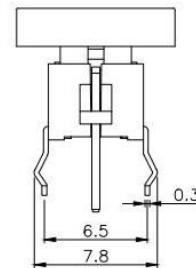
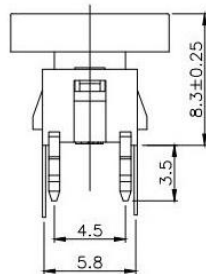
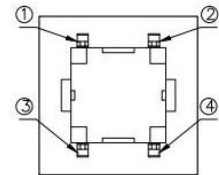
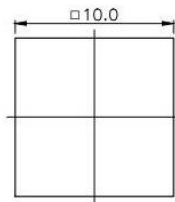

TS8-3B3WU

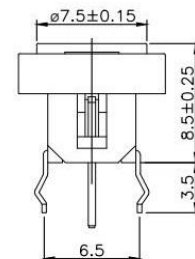
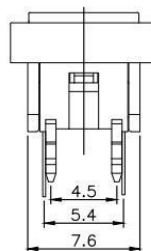
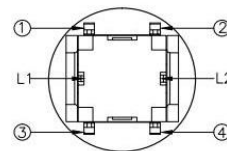
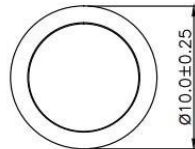

TS8-1A2AG

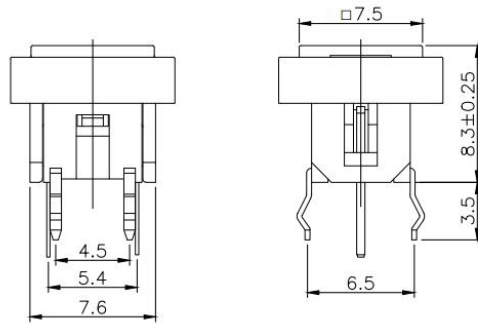
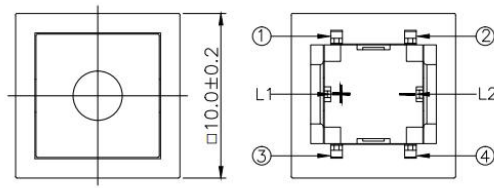

TS8-0030AU1

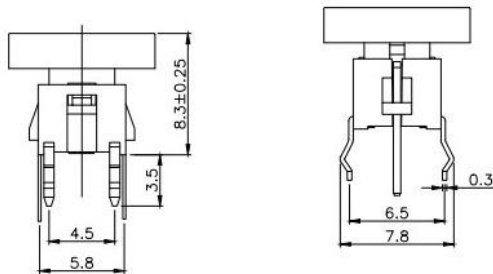

TS8-00TWR

